

Contents

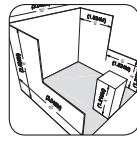

Linear Booth and Corner Booth

4

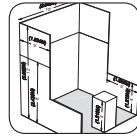

Perimeter Booth

5

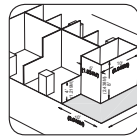

End-cap Booth

6

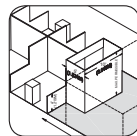

Peninsula Booth

7

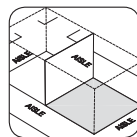

Split Island Booth

8

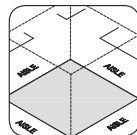

Island Booth

9

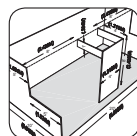

Extended Header Booth

10

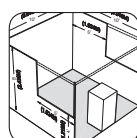

Other Important Considerations

11

Issues Common To All Booth Types

12-14

Advisory Notes To Exhibition Organizers

15-16

Guidelines for Display Rules and Regulations 2014 Update

The following *Guidelines for Display Rules and Regulations* have been established by the International Association of Exhibitions and Events™ (IAEE). *Guidelines for Display Rules and Regulations* are created to promote continuity and consistency among North American exhibitions and events. They are the model for most domestic exhibitions and events. It is recommended that exhibition organizers include a copy in the Exhibition Prospectus and/or Exhibitor Rules and Regulations.

This revised 2014 edition of IAEE's *Guidelines for Display Rules and Regulations* is offered as a resource for exhibitions and events organizers to use in creating consistent and fair exhibiting standards for their events. These *Guidelines* afford exhibitors a maximum return on their exhibit investments. Compliance with fire, safety, Americans with Disabilities Act (ADA), and other state, federal or provincial government requirements has also been addressed. However, always check with a local exhibition service contractor and the facility for local regulations.

It is IAEE's goal that the display rules and regulations, ultimately developed by each exhibitions and events organizer, shall provide exhibitors with all the information necessary to properly design and build exhibits, as well as plan their booth's layout and content. Show organizers should present the professional standards expected of exhibitors. Finally, they should assure all exhibitors, regardless of exhibit size or location, an environment conducive to successful interaction with their audiences.

IAEE is a global association that serves as the foremost authority on exhibitions and events management and operations.

**For display rules and regulations specific to an exhibition or event,
consult the exhibition or event organizer.**

Linear Booth

Linear Booths, also called “in-line” booths, are generally arranged in a straight line and have neighboring exhibitors on their immediate right and left, leaving only one side exposed to the aisle.

Dimensions

For purposes of consistency and ease of layout and/or reconfiguration, floor plan design in increments of 10ft (3.05m) has become the de facto standard in the United States. Therefore, unless constricted by space or other limitations, Linear Booths are most commonly 10ft (3.05m) wide and 10ft (3.05m) deep, i.e. 10ft by 10ft (3.05m by 3.05m). A maximum back wall height limitation of 8ft (2.44m) is generally specified.

Use of Space

Regardless of the number of Linear Booths utilized, e.g. 10ft by 20ft (3.05m by 6.10m), 10ft by 30ft (3.05m by 9.14m), 10ft by 40ft (3.05m by 12.19m), etc. display materials should be arranged in such a manner so as not to obstruct sight lines of neighboring exhibitors. The maximum height of 8ft (2.44m) is allowed only in the rear half of the booth space, with a 4ft (1.22m) height restriction imposed on all materials in the remaining space forward to the aisle. (See Line-of-Sight exception on page 8.) Note: When three or more Linear Booths are used in combination as a single exhibit space, the 4ft (1.22m) height limitation is applied only to that portion of exhibit space which is within 10ft (3.05m) of an adjoining booth.

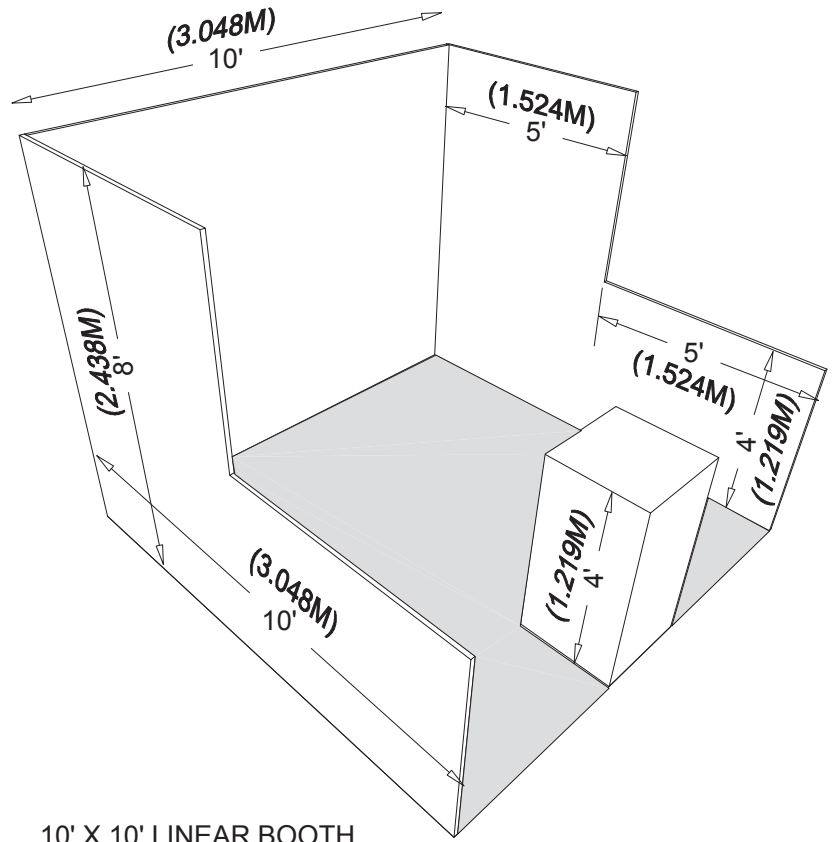
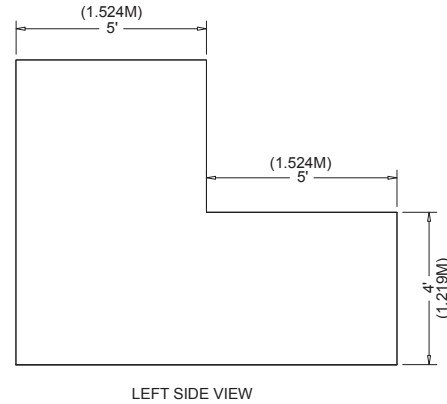
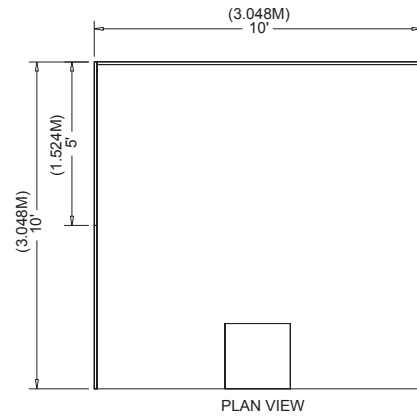

10' X 10' LINEAR BOOTH

Corner Booth

A Corner Booth is a Linear Booth at the end of a series of in-line booths with exposure to intersecting aisles on two sides. All other guidelines for Linear Booths apply.

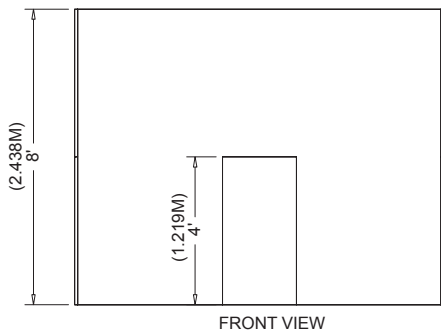

FRONT VIEW

Perimeter Booth

A Perimeter Booth is a Linear Booth that backs to an outside wall of the exhibit facility rather than to another exhibit.

Dimensions and Use of Space

All guidelines for Linear Booths apply to Perimeter Booths except that the typical maximum back wall height is 12ft (3.66m).

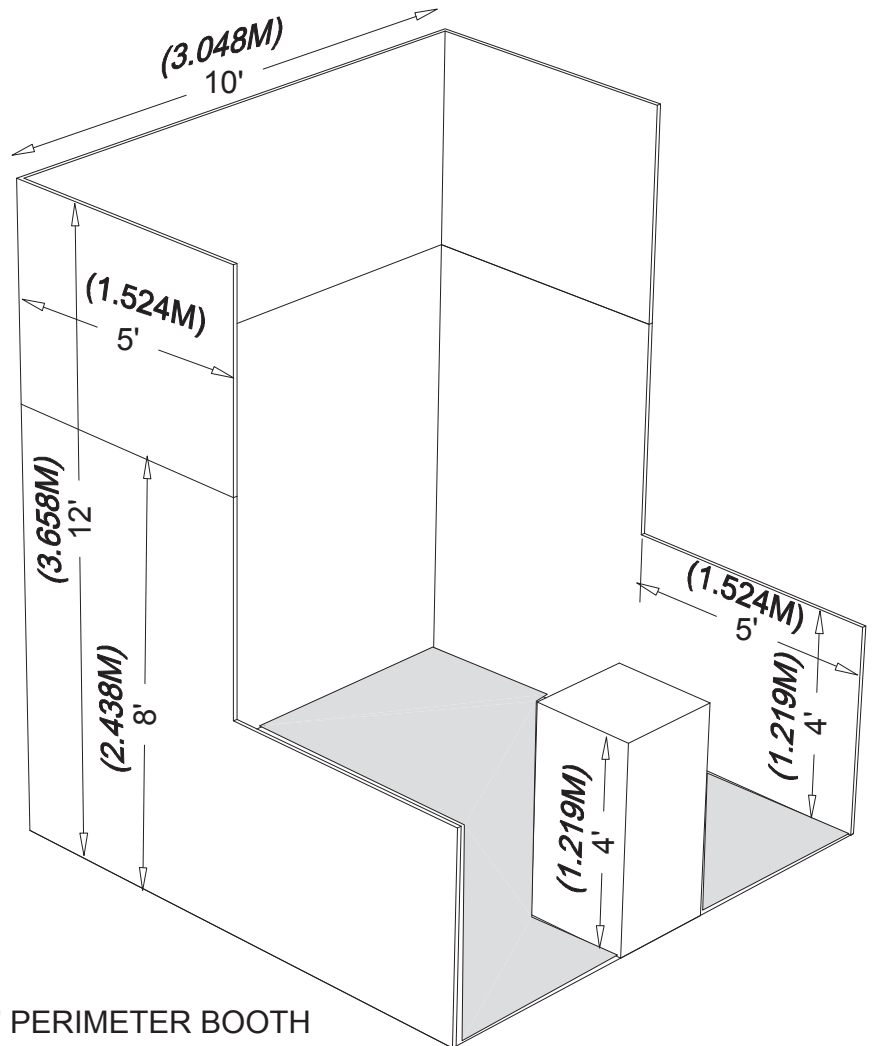
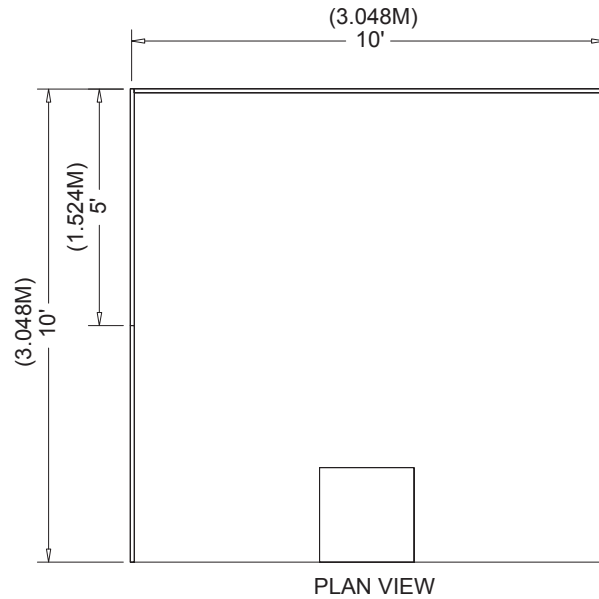
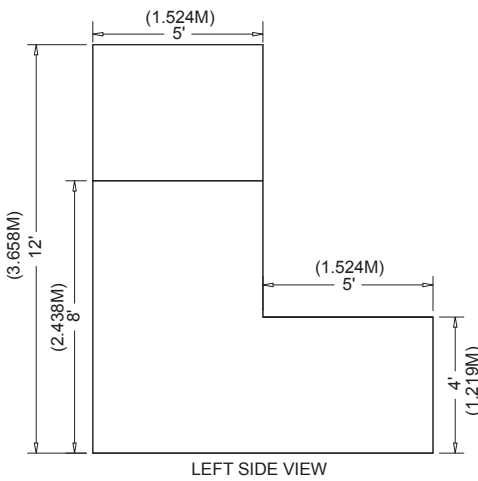
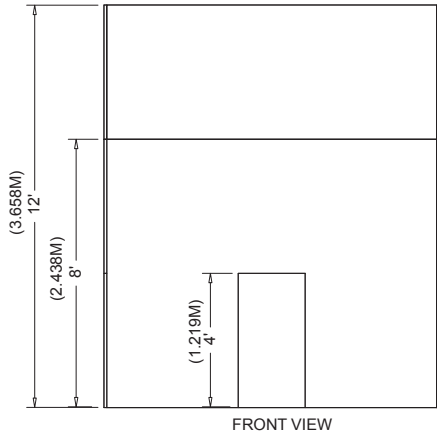

End-cap Booth

An End-cap configuration is essentially an in-line (linear) booth placed in the position of a Peninsula or Split Island. For shows that have Line-of-Sight rules and not cubic content, this configuration must follow the dimensions below. For shows that have cubic content rules, the space may be used without restriction.

Dimensions

End-cap Booths are generally 10ft (3.05m) deep by 20ft (6.10m) wide. The maximum back wall height allowed is 8ft (2.44m) and the maximum back-wall width allowed is 10ft (3.05m) at the center of the back-wall with a maximum 5ft (1.52m) height on the two side aisles. Within 5' of the 2 side aisles, the maximum height for any display materials is 4'.

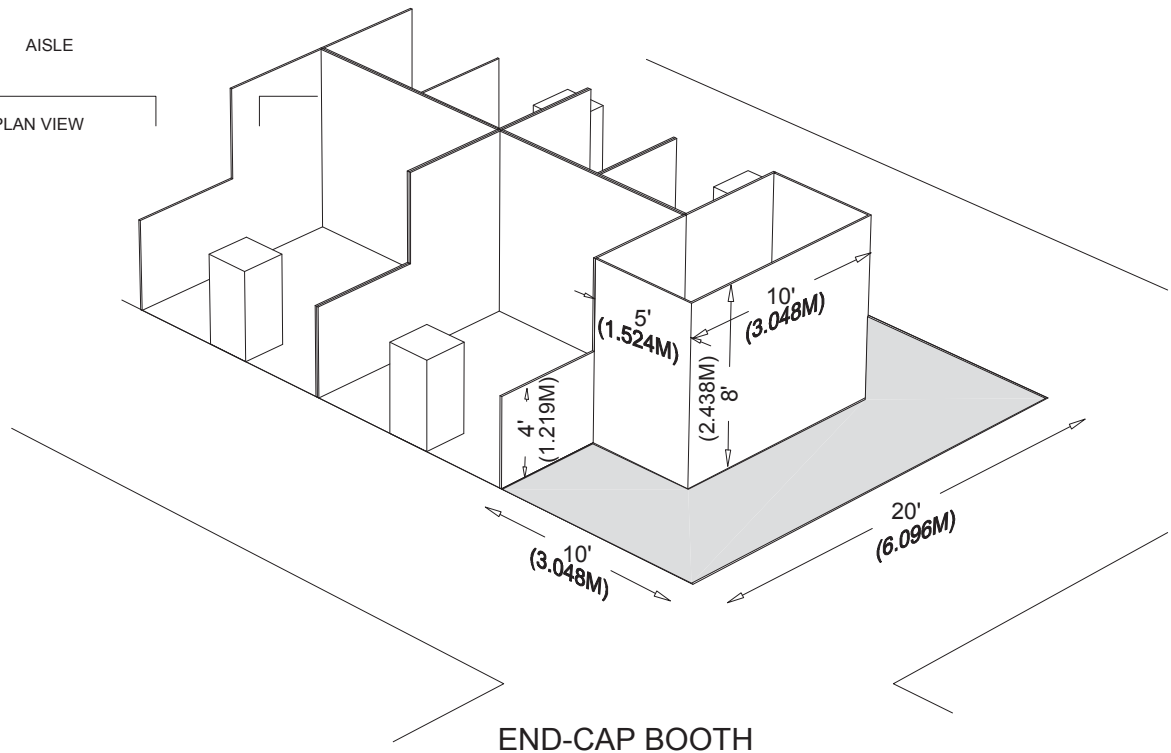
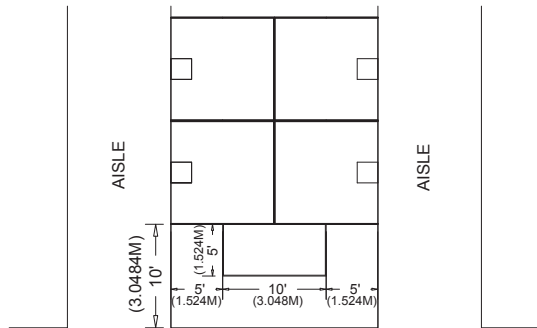
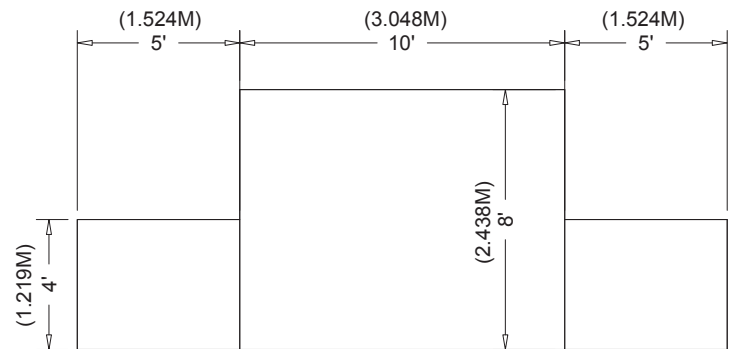
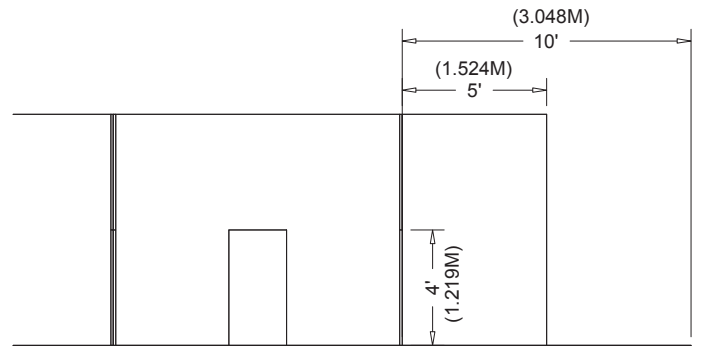

Peninsula Booth

A Peninsula Booth is exposed to aisles on three sides, and comprised of a minimum of four booths. There are two types of Peninsula Booths: (a) one which backs to Linear Booths, and (b) one which backs to another Peninsula Booth and is referred to as a “Split Island Booth.”

Dimensions

A Peninsula Booth is usually 20ft by 20ft (6.10m by 6.10m) or larger. When a Peninsula Booth backs up to two Linear Booths, the back wall is restricted to 4ft (1.22m) high within 5ft (1.52m) of each aisle, permitting adequate line of sight for the adjoining Linear Booths. (See Line-of-Sight exception on page 8.) A typical maximum height range allowance is 16ft to 20ft (4.88m to 6.10m), including signage for the center portion of the back wall. Double-sided signs, logos and graphics shall be set back ten feet (10') (3.05m) from adjacent booths.

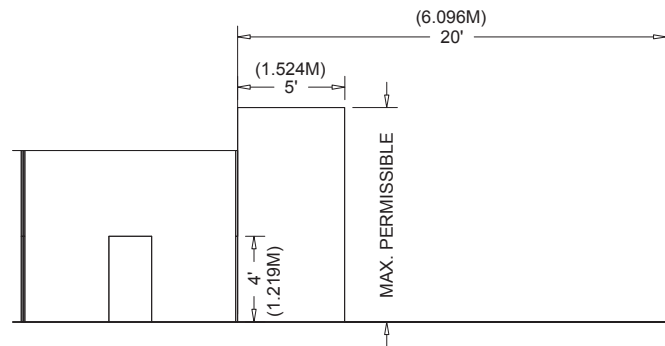
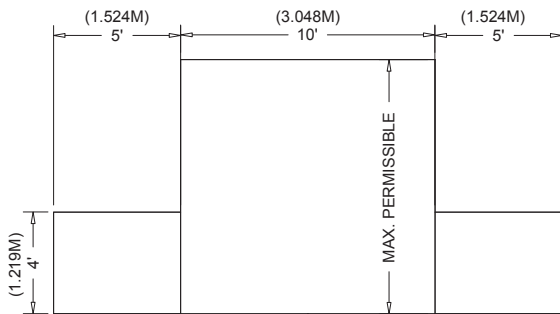
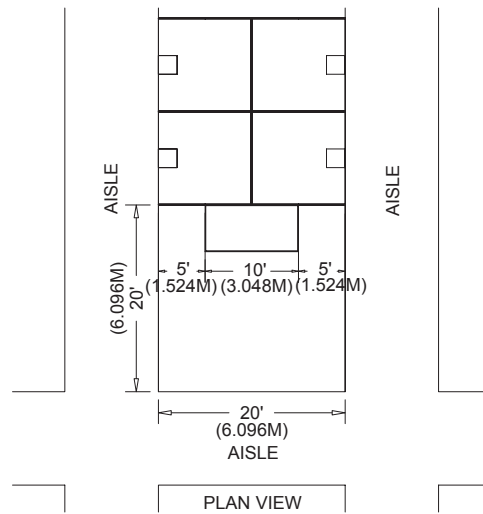

FRONT VIEW

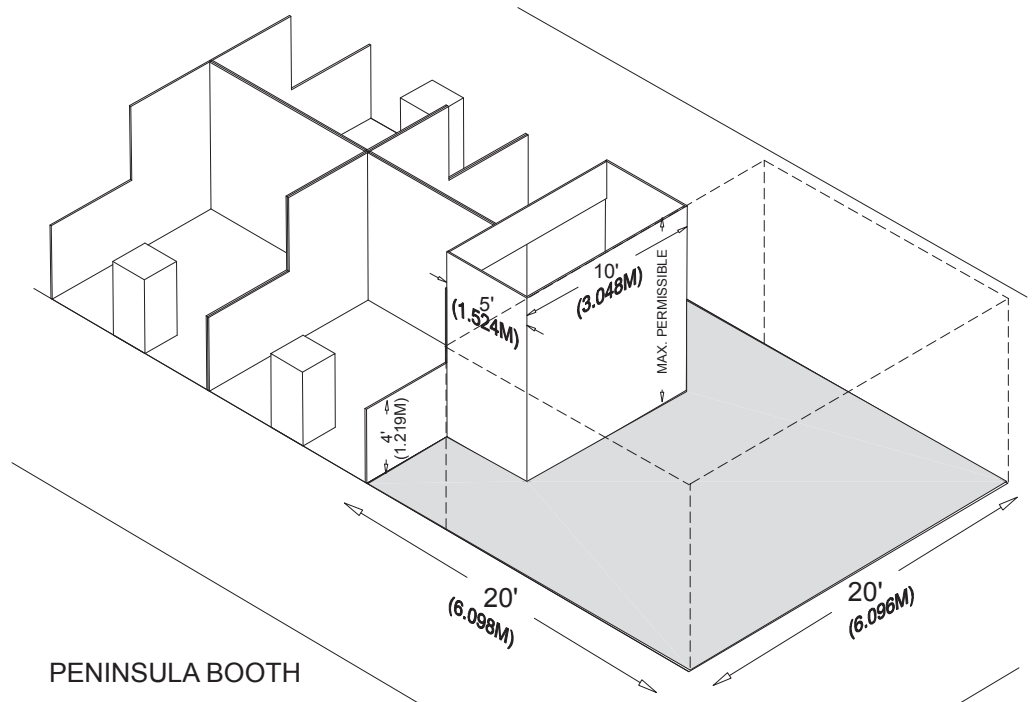

Split Island Booth

A Split Island Booth is a Peninsula Booth which shares a common back wall with another Peninsula Booth. The entire cubic content of this booth may be used, up to the maximum allowable height, without any back wall Line-of-Sight restrictions. A typical maximum height range allowance is 16ft to 20ft (4.88m to 6.10m), including signage. The entire cubic content of the space may be used up to the maximum allowable height. Double-sided signs, logos and graphics shall be set back ten feet (10') (3.05m) from adjacent booths.

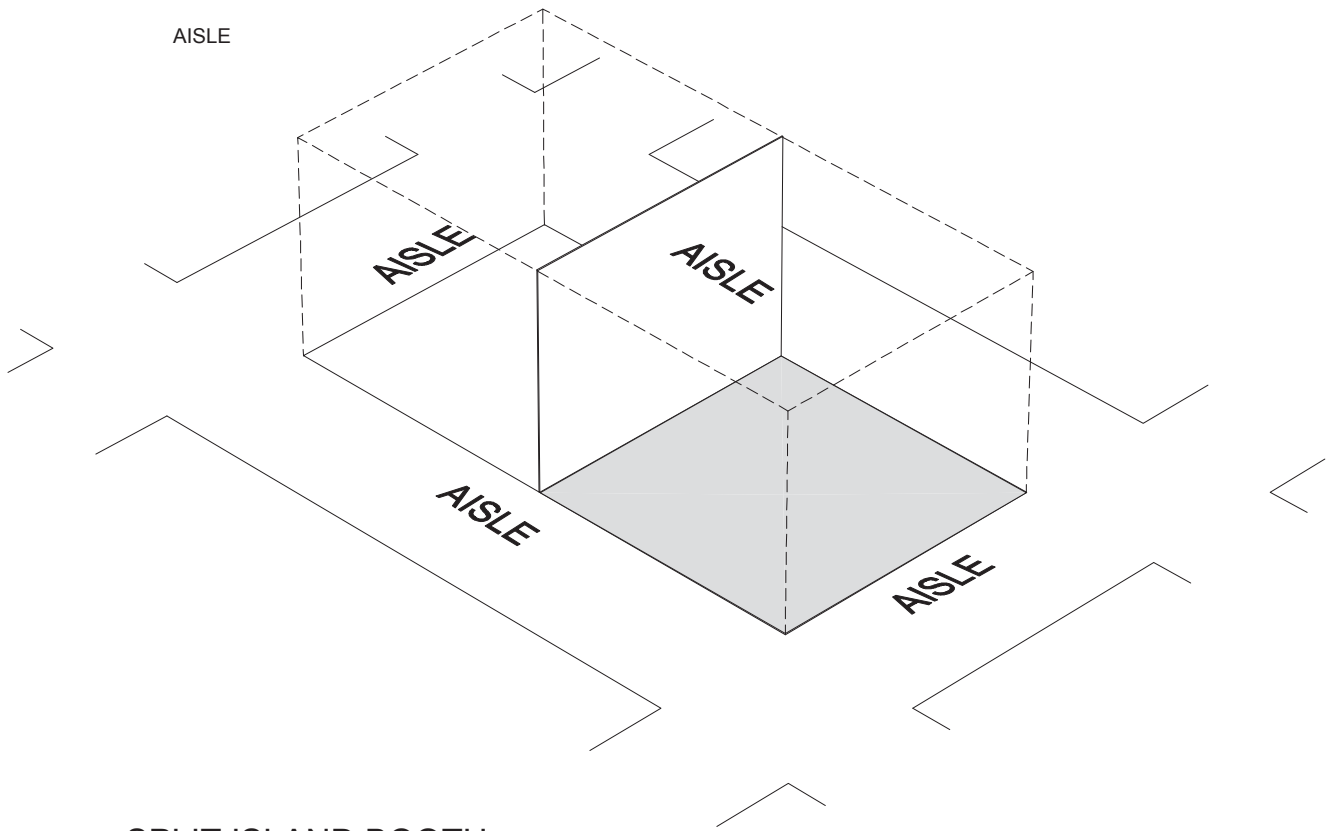
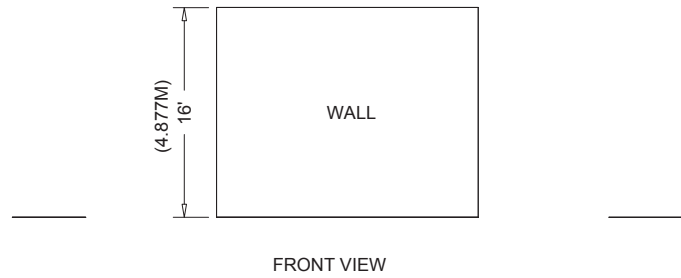
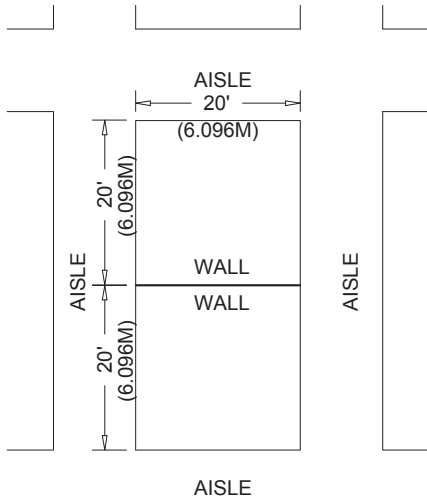
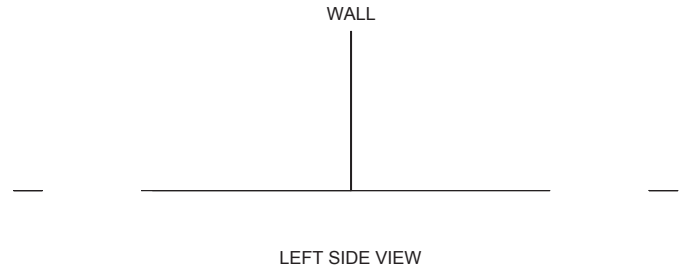

SPLIT ISLAND BOOTH

Island Booth

An Island Booth is any size booth exposed to aisles on all four sides.

Dimensions

An Island Booth is typically 20ft by 20ft (6.10m by 6.10m) or larger, although it may be configured differently.

Use of Space

The entire cubic content of the space may be used up to the maximum allowable height, which is usually a range of 16ft to 20ft (4.88m to 6.10m), including signage.

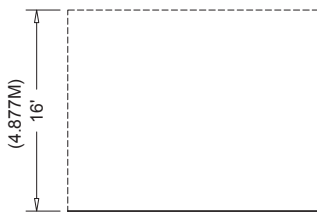
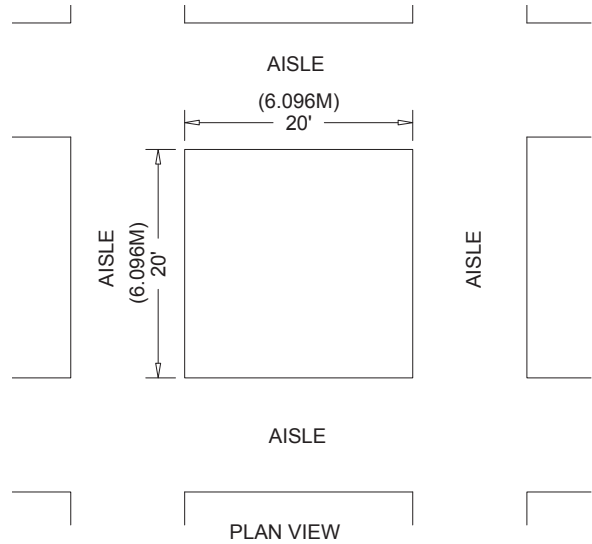

FRONT VIEW

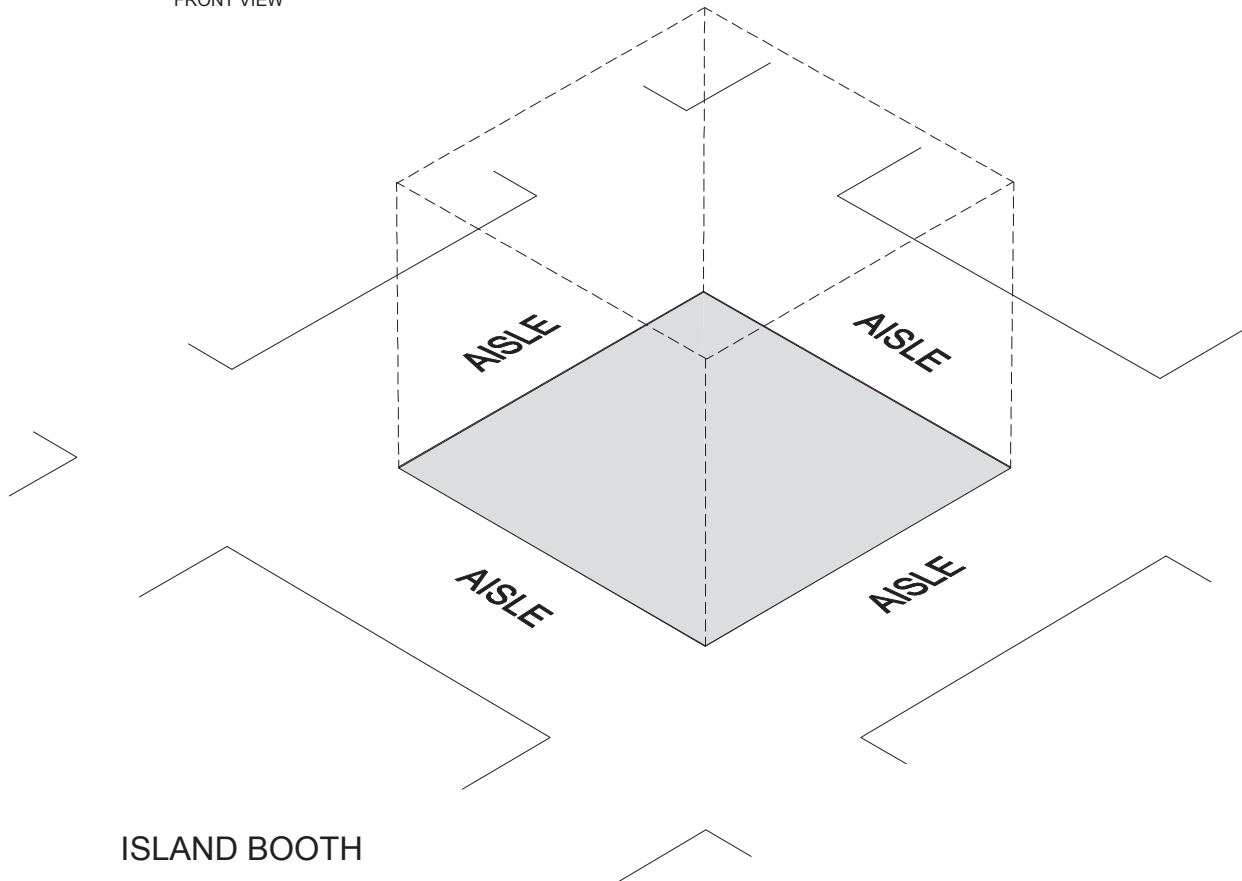

Extended Header Booth 20ft (6.10m) or Longer

An Extended Header Booth is a Linear Booth 20ft (6.10m) or longer with a center extended header.

Dimensions and Use of Space

All guidelines for Linear Booths apply to Extended Header Booths, except that the center extended header has a maximum height of 8ft (2.44m), a maximum width of 20 percent of the length of the booth, and a maximum depth of 9ft (2.7m) from the back wall.

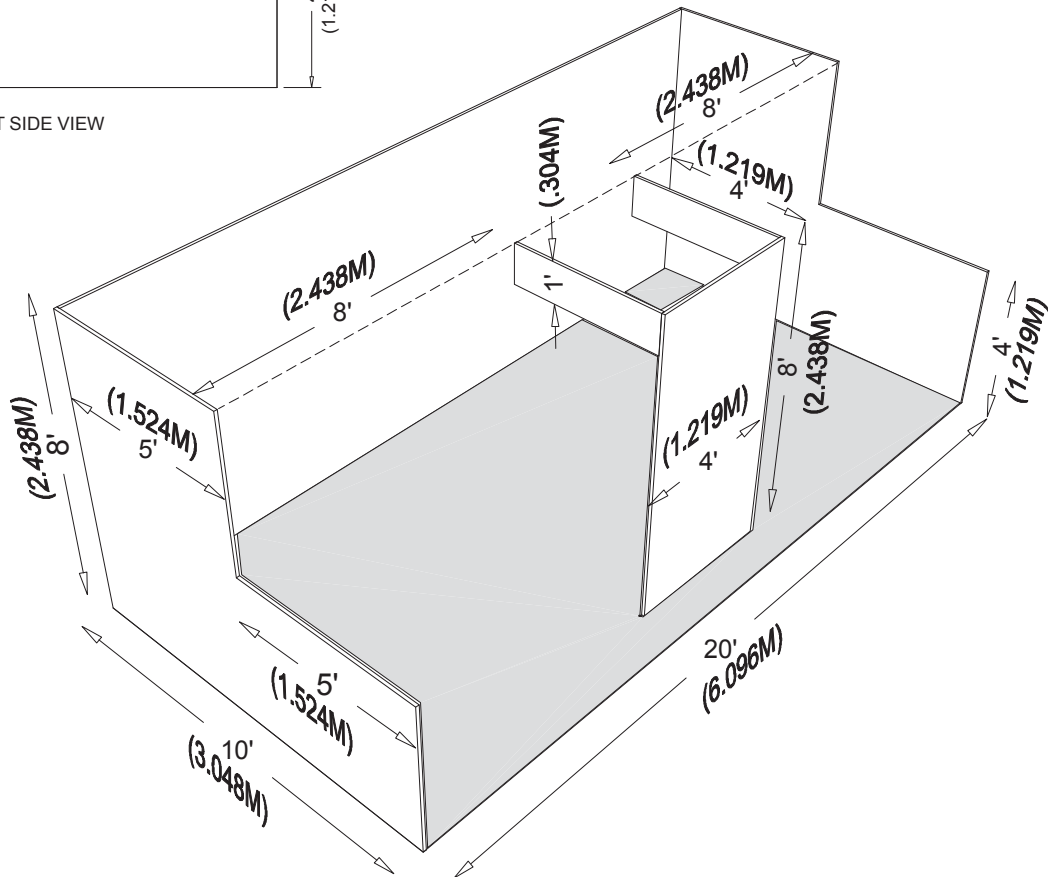
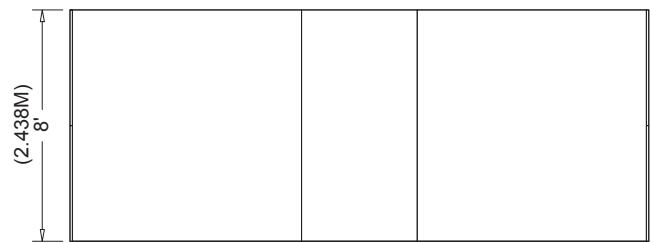
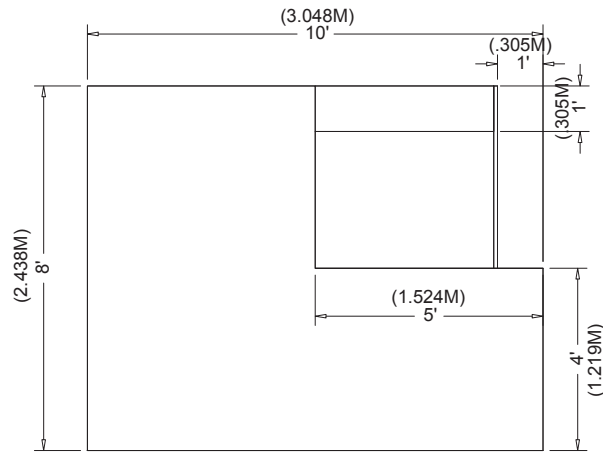
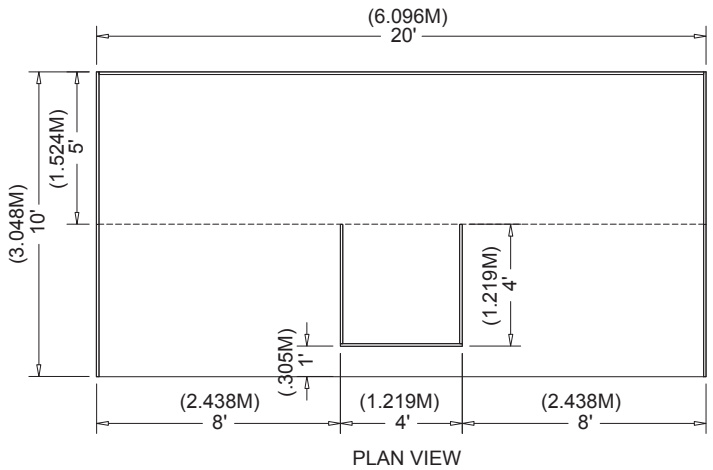

10' X 20' EXTENDED HEADER BOOTH

Other Important Considerations

Canopies and Ceilings

Canopies, including ceilings, umbrellas and canopy frames, can be either decorative or functional (such as to shade computer monitors from ambient light or to allow for hanging products). Canopies for Linear or Perimeter Booths should comply with Line-of-Sight requirements. (See “Use of Space” for Linear or Perimeter Booths).

The bottom of the canopy should not be lower than 7ft (2.13m) from the floor within 5ft (1.52m) of any aisle. Canopy supports should be no wider than three inches 3in (.08m). This applies to any booth configuration that has a sight line restriction, such as a Linear Booth. Fire and safety regulations in many facilities strictly govern the use of canopies, ceilings and other similar coverings. Check with the appropriate local agencies prior to determining specific exhibition rules.

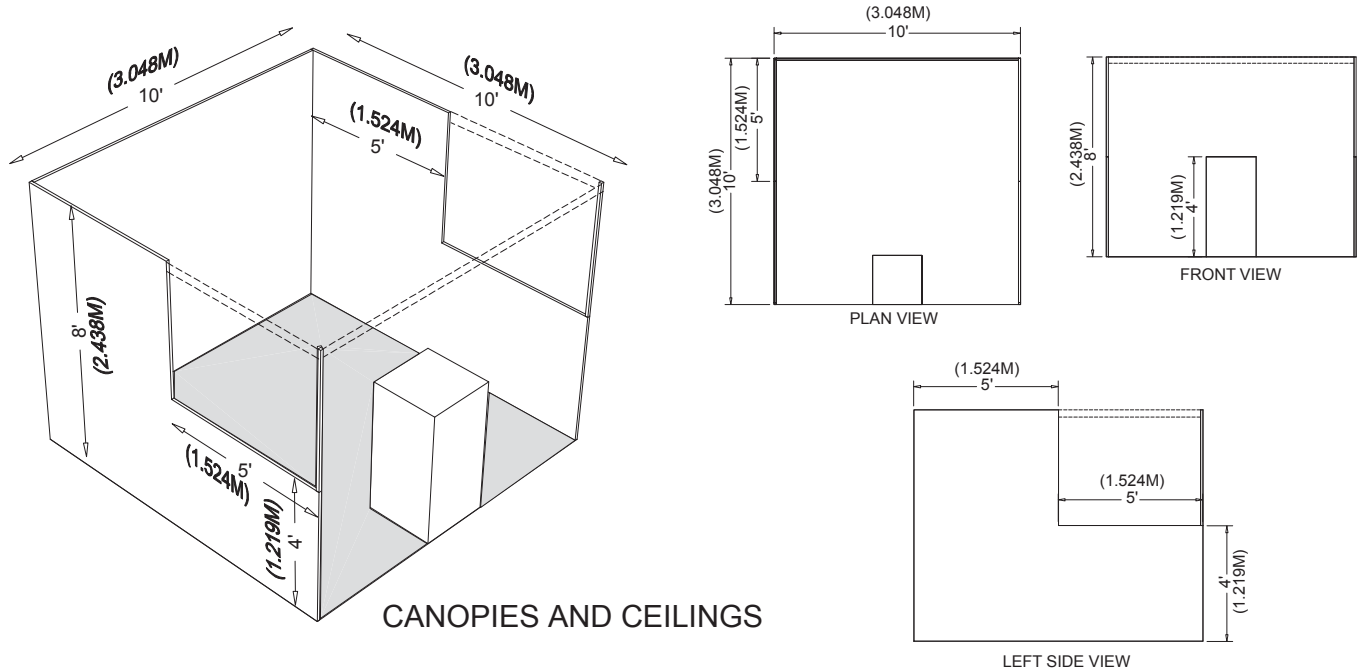

CANOPIES AND CEILINGS

Hanging Signs & Graphics

Most exhibitions and events rules allow for Hanging Signs and Graphics in all standard Peninsula and Island Booths, usually to a maximum height range of 16ft to 20ft (4.88m to 6.10m) from the top of the sign, or as determined by the show organizer. End-cap Booths do not qualify for Hanging Signs and Graphics. The distance is measured from the floor to the top of the sign. Whether suspended from above, or supported from below, they should comply with all ordinary use-of-space requirements. For example, the highest point of any sign should not exceed the maximum allowable height for the booth type.

Hanging Signs and Graphics should be set back 10ft (3.05m) from adjacent booths and be directly over contracted space only.

Approval for the use of Hanging Signs and Graphics, at any height, should be received from the exhibitions or events organizer at least 60 days prior to installation. Variances may be issued at the exhibitions or events management’s discretion. Drawings should be available for inspection.

Towers

A Tower is a free-standing exhibit component separate from the main exhibit fixture. The height restriction is the same as that which applies to the appropriate exhibit space configuration being used.

Towers in excess of 8ft (2.44m) should have drawings available for inspection. Fire and safety regulations in many facilities strictly govern the use of Towers. A building permit or safety lines may be required.

Multi-story Exhibit

A Multi-story Exhibit is a booth where the display fixture includes two or more levels. In many cities, a Multi-story Exhibit requires prior approval by the exhibit facility, and/or relevant local government agency, as well as show management because it is deemed to be a “structure” for building purposes. The city building department generally needs to issue a building permit based on an application and drawings prepared and submitted by a licensed architect or engineer. Exhibitors should obtain local building regulations early on to ensure that all time constraints are met. Exhibitions and events organizers should be prepared to assist exhibitors in this application process.

Issues Common To All Booth Types

Americans with Disabilities Act (ADA)

All exhibiting companies are required to be in compliance with the Americans with Disabilities Act (ADA), and are encouraged to be sensitive, and as reasonably accommodating as possible, to attendees with disabilities. Information regarding ADA compliance is available from the U.S. Department of Justice ADA Information Line (800) 514-0301, and from the ADA website at www.ada.gov. Some examples of how to design an exhibit for ADA compliance:

- Make exhibits wheelchair accessible by ramping raised exhibit flooring without extending a ramp into the aisle. Note: a standard wheelchair ramp should have a grade no steeper than 1:12. This means that for every inch of rise (change in height), there should be 12 inches of run (change in length)
- Ramp the entry or use hydraulic lifts to trailer exhibits
- Avoid double-padded plush carpet to ease mobility device navigation
- Provide the same attendee experience on both levels of a two-story exhibit
- Offer a signer or other auxiliary hearing-impaired apparatus for sound presentations or have a printed copy of the presentation available
- Run an audio presentation for people with sight problems
- Arrange touch screen displays at a height to accommodate a person sitting in a wheelchair

To avoid heavy fines by the U. S. Department of Justice, exhibitors must adhere to the ADA rules. Exhibits are not exempt from ADA compliance.

Structural Integrity

All exhibit displays should be designed and erected in a manner that will withstand normal contact or vibration caused by neighboring exhibitors, hall laborers, or installation/dismantling equipment, such as fork lifts. Displays should also be able to withstand moderate wind effects that may occur in the exhibit hall when freight doors are open. Refer to local building codes that regulate temporary structures.

It is recommended that all 20ft by 20ft (6.10m by 6.10m) and over exhibits require a drawing, plans or renderings, preferably digital, to be submitted to the show organizer, and to the show's general service contractor.

Exhibitors should ensure that any display fixtures such as tables, racks, or shelves are designed and installed properly to support the product or marketing materials to be displayed.

Flammable and Toxic Materials

All materials used in display construction or decorating should be made of fire retardant materials and be certified as flame retardant. Samples should also be available for testing. Materials that cannot be treated to meet the requirements should not be used. A flame-proofing certificate should be available for inspection. Exhibitors should be aware of local regulations regarding fire/safety and environment which must be adhered to.

Exhibitors should dispose of any waste products they generate during the exhibition in accordance with guidelines established by the Environmental Protection Agency and the facility.

Storage

Fire regulations in most exhibit facilities prohibit storing product, literature, empty packing containers, or packing materials behind back drapes or under draped tables. In most cases, however, exhibitors may store a limited supply of literature or product appropriately within the booth area, so long as these items do not impede access to utility services, create a safety problem, or look unsightly.

Issues Common To All Booth Types *(continued)*

Electrical

Every exhibit facility has different electrical requirements. However, minimum guidelines are suggested:

- All 110-volt wiring should be grounded three-wire.
- Wiring that touches the floor should be “SO” cord (minimum 14-gauge/three-wire) flat cord, which is insulated to qualify for “extra hard usage.”
- Cord wiring above floor level can be “SJ” which is rated for “hard usage.”
- Using zip cords, two-wire cords, latex cords, plastic cords, lamp cords, open clip sockets, and two-wire clamp-on fixtures is not recommended and is often prohibited. Cube taps should be prohibited.
- Power strips (multi-plug connectors) should be UL approved, with built-in over-load surge protectors.

Lighting

Exhibitors should adhere to the following suggested minimum guidelines when determining booth lighting:

- No lighting, fixtures, lighting trusses, or overhead lighting are allowed outside the boundaries of the exhibit space. Exhibitors intending to use hanging light systems should submit drawings to exhibition management for approval.
- Lighting, including gobos, should be directed to the inner confines of the booth space. Lighting should not project onto other exhibits or exhibition aisles.
- Lighting that is potentially harmful, such as lasers, ultraviolet lights or flashing or strobe lights that can trigger photosensitive epilepsy should comply with facility rules and be approved in writing by exhibition management.
- Lighting that spins, rotates, pulsates, and other specialized lighting effects should be in good taste and not interfere with neighboring exhibitors or otherwise detract from the general atmosphere of the event.
- LED lights can be very bright yet generally generate less heat.
- Currently, some convention facilities are not allowing certain types of quartz halogen lighting fixtures in exhibits due to potential fire hazards. Check with exhibition management.
- Reduced lighting for theater areas should be approved by the exhibition organizer, the utility provider, and the exhibit facility.

Demonstrations

As a matter of safety and courtesy to others, exhibitors should conduct sales presentations and product demonstrations in a manner which assures all exhibitor personnel and attendees are within the contracted exhibit space and not encroaching on the aisle or neighboring exhibits. It is the responsibility of each exhibitor to arrange displays, product presentation, audio visual presentations, and demonstration areas to ensure compliance. Exhibitors should be aware of local regulations regarding fire/safety and environment which must be adhered to.

Special caution should be taken when demonstrating machinery or equipment that has moving parts, cooking equipment with an open flame, or any product that is otherwise potentially dangerous. Exhibitors should establish a minimum setback of 3ft (.91m) and/or install hazard barriers as necessary to prevent accidental injury to spectators. Additionally, demonstrations should only be conducted by qualified personnel.

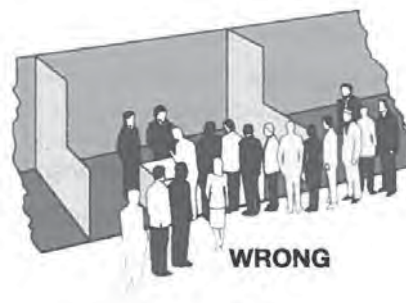
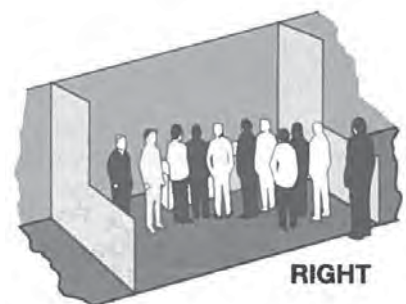

Issues Common To All Booth Types *(continued)*

Sound/Music

In general, exhibitors may use sound equipment in their booths so long as the noise level does not disrupt the activities of neighboring exhibitors. Speakers and other sound devices should be positioned so as to direct sound into the booth rather than into the aisle. Rule of thumb: Sound and noise should not exceed 85 decibels when measured from the aisle immediately in front of a booth. (Refer to OSHA at www.osha.gov for more information.)

Exhibitors should be aware that music played in their booths, whether live or recorded, may be subject to laws governing the use of copyrighted compositions. ASCAP, BMI, and SESAC are three authorized licensing organizations that collect copyright fees on behalf of composers and publishers of music.

Vehicles

Vehicles: Rules vary depending on the facility, but generally it is required that vehicles on display have no more than one fourth tank of gas. The filler cap should be sealed and the batteries disconnected. External chargers are usually recommended for demonstration purposes. Keys should always be surrendered to show management while participating in an exhibition or event.

Advisory Notes To Exhibition Organizers

End-cap Booths: End-cap Booths cause more problems between exhibitors than any other type of booth, because most exhibitors fail to observe back wall height restrictions. Exhibition managers should be alert to exhibitors reserving End-cap configurations to ensure they do not violate Linear Booth Line-of-Sight regulations for neighboring exhibits.

Fire Equipment: Fire hoses, extinguishers, and audible or visual devices for fire alarms should be visible and accessible at all times.

Hanging Signs: Although these *Guidelines* indicate 16ft to 20ft (4.88m to 6.10m) as a maximum height range from the top of the sign, some exhibitions permit other heights, or have no height limit. Caution should be exercised so exhibitors will not compete over air space for Hanging Signs. Most show organizers limit the height of signs.

Exhibitors should be advised to install “hanging points” at the time of manufacture of the sign or display. It is also advisable to have Hanging Signs labeled and cased separately so that they can be easily identified on-site as they usually must be installed before other exhibit construction can begin.

Hardwall Booths: Exhibitions that provide Hardwall Booths should specify if these structures can be used for display and attaching products.

Full Cubic Content in Linear Space: It is the responsibility of the exhibitions or events organizer to establish rules to best achieve the goals for their exhibition or event based on the nature of their exhibition and event, and industry sector it serves.

Cubic Content Definition: Using the perimeter lines of a booth as a guide, the exhibitor may install a booth up to these lines and utilize all the volume of space within these lines up to the maximum height permitted by the show rules as determined by the show organizer.

It is the choice of the exhibitions or events organizer to allow use of full Cubic Content in linear exhibit space or to observe the Line-of-Sight set-back rule. It is common at certain types of exhibitions or events to eliminate the Line-of-Sight requirement for Linear, End-cap, and Peninsula Booths that back up to Linear Booths. This permits exhibitors to utilize the full Cubic Content of the booth.

Organizers that permit use of Cubic Content in Linear Booths do so for one or all of these reasons:

- Cubic Content is more conducive to certain types of product displays or experiences.
- Cubic Content maximizes the exhibit space and investment.
- International exhibitions generally utilize Cubic Content making the show friendlier to international exhibitors.
- Cubic Content reduces the need to police exhibits to enforce setback rules.

Use of Cubic Content may create situations where the organizer must address exhibits that have unfinished walls. A determination must be made as to responsibility for finishing these unfinished walls.

It is prudent for the exhibitions or events organizer considering Cubic Content to examine the concerns, advantages and disadvantages prior to putting Cubic Content guidelines into practice. It is often wise to consult with the exhibition’s Exhibits Advisory Board or perhaps conduct a focus group of the exhibition’s or event’s exhibitors to determine their interest and gain their feedback and support for the concept. Exhibitions and events organizers must be proactive in communicating with exhibitors and understanding the effect it will have on the exhibition or event.

To learn more about Full Cubic Content, read the IAEE White Paper: **Evaluating and Implementing Cubic Content into Linear Exhibit Space.**

Advisory Notes To Exhibition Organizers *(continued)*

Perimeter Openings: Large Peninsulas and Islands with long high walls can create a “tunnel-like” effect. Exhibitors may be required to install a minimum 6ft (1.83m) opening every 30ft (9.14m).

Pipe and Drape: These are commonly used at exhibitions and events in the United States to define exhibit space. Exhibitions and events organizers often include in their rules and regulations that this equipment is not intended as a display fixture. Therefore, product and signs should not be attached or affixed. Measurements of booths must allow for size of pipe on sides and back.

Product Height: Some exhibitors have products that exceed display height restrictions. Exhibitions and events organizers should establish guidelines for displaying such products. For example, some exhibitions or events require that these exhibitors reserve only perimeter space. Products exceeding height restrictions for Islands and Peninsulas are usually permitted, providing they are displayed in operating mode, and the names and logos, etc. on the product are as it is sold.

Height Variances: Height Variances may be issued for all types of booths. However, in a Linear Booth, the back side of any structure over 8ft (2.44m) must be free of trademarks, graphics and/or logos.

Environmental Responsibility: Exhibitions and events, by their very nature, create waste. Properly managed, exhibitions and events can recycle excess materials and supplies in useful and meaningful ways, and they can do so using methods that result in minimized impact on the environment. Exhibits should utilize recycled, renewable and energy efficient materials whenever possible.



Exhibitions and Events Mean Business
www.iaee.com

12700 Park Central Drive, Suite 308
Dallas, TX 75251-1500
USA

www.iaee.com